



## Description

## Package Marking and Ordering Information

Device Marking	Device	OUTLINE	Device Package	Reel Size	Reel (PCS)	Per Carto
----------------	--------	---------	----------------	-----------	------------	-----------





## P-Channel Electrical Characteristics

Symbol	Parameter	Test Condition	Min.	Typ.	Max.	Units
Off Characteristic						

On Characteristics



Typical Performance Characteristics-N

Figure1:

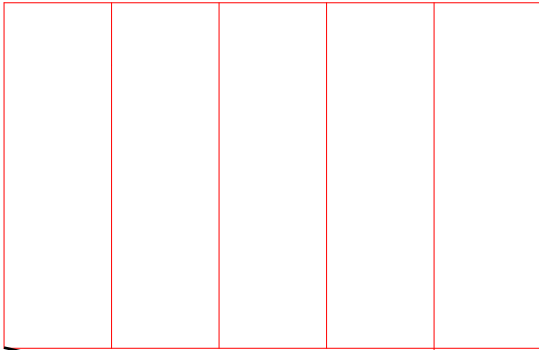

Figure 2:

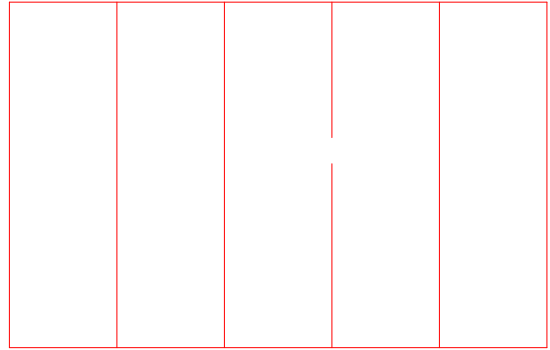

Figure 3:

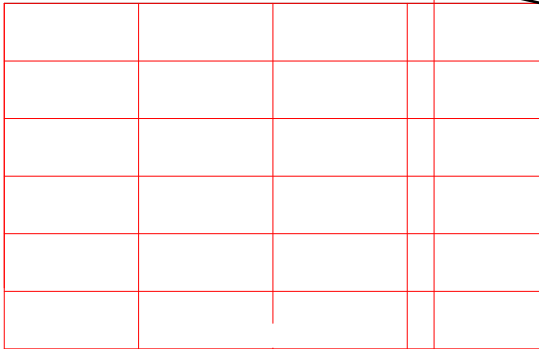

Figure 4



Figure 5:



0

↓



**Figure 7:**



**Figure 8:**

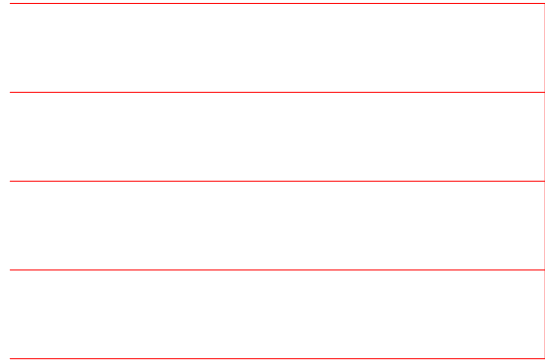

**Figure 9:**

)





**Typical Performance Characteristics-P**

Figure 7:



Figure 8:

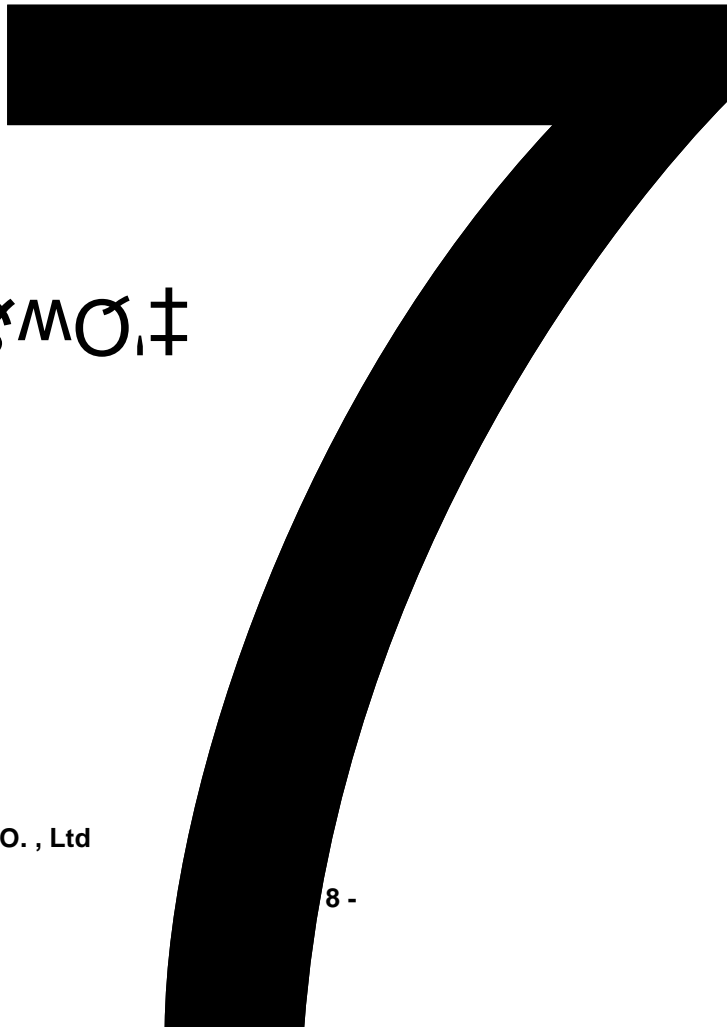

Figure 9:



Figure 10:

)



© " 8M0,±

## Test Circuit-P

Gate Charge Test Circuit & Waveform

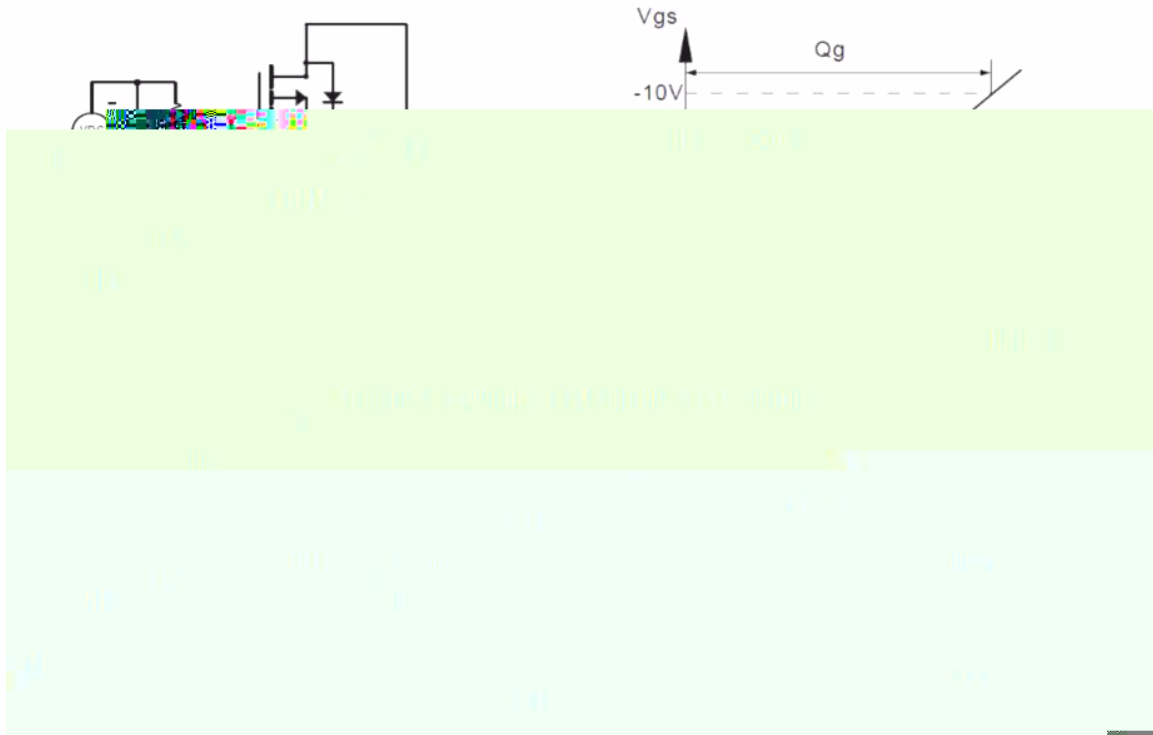

Unclamped Inductive Switching (UIS) Test Circuit & Waveforms

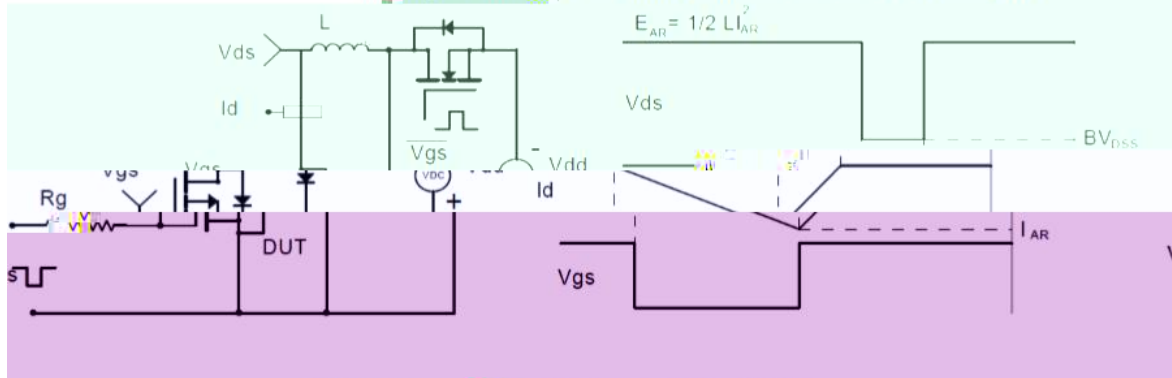

Diode Recovery Test Circuit & Waveforms

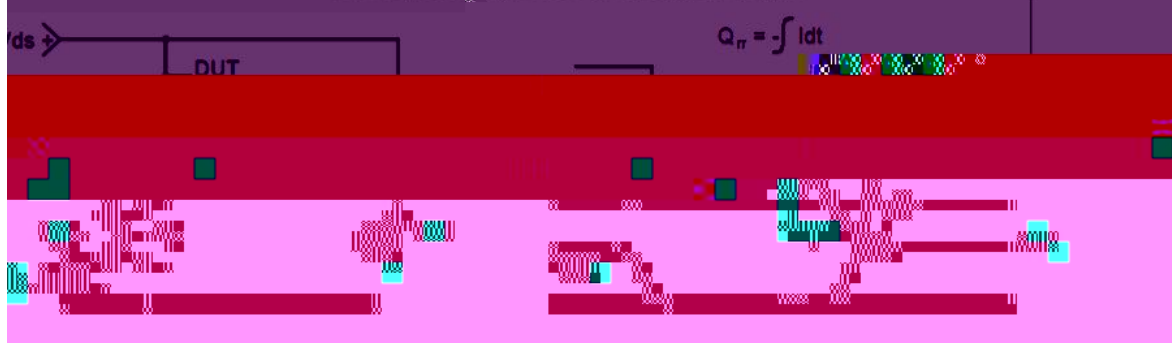



## Package Mechanical Data-SOP-8

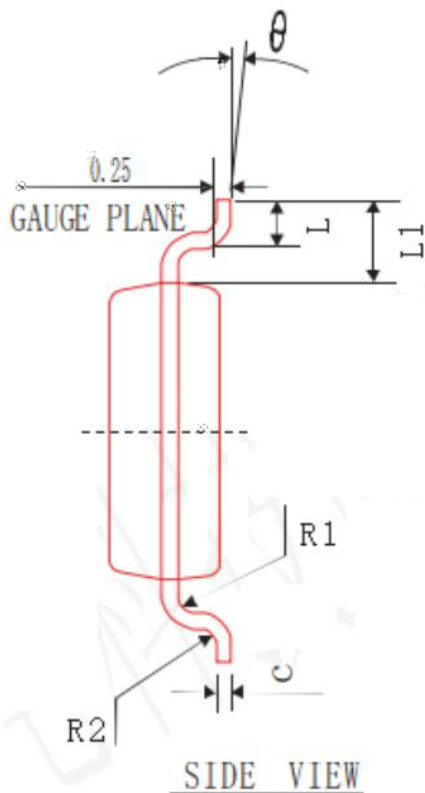
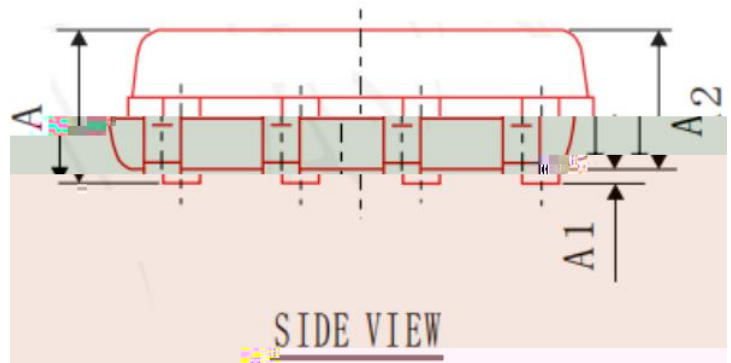
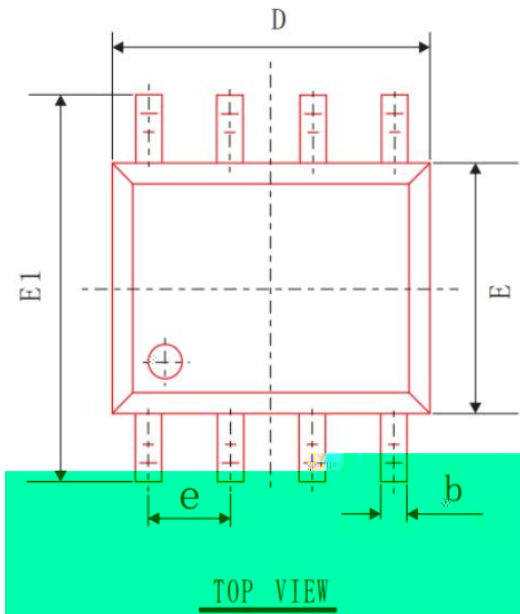

SYMBOL	MIN	NOM	MAX
A	1.40	1.60	1.80
A1	0.05	0.15	0.25
A2	1.35	1.45	1.55
b	0.30	0.40	0.50
c	0.153	0.203	0.253
L	4.80	4.90	5.00
E	3.80	3.90	4.00
E1	5.80	6.00	6.20
L	0.45	0.70	1.00
$\theta$	2°	4°	6°
L1	1.04 REF		
e	1.27 BSC		
R1	0.07 TYP		
R2	0.07 TYP		

